

edilportale® TOUR 2015

IN COLLABORAZIONE CON



La Mostra Convegno in 20 tappe su
Architettura sostenibile, Efficienza
energetica, Comfort abitativo, Active
House, Costruzioni in legno, Antisismica,
Antincendio, Tecnologie costruttive.

Catania, 26 marzo 2015

RhOME for denCity: il Social housing per rivitalizzare la periferia

Chiara Tonelli

Energy Use in Europe

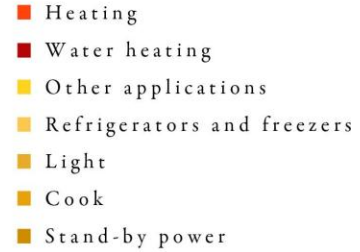
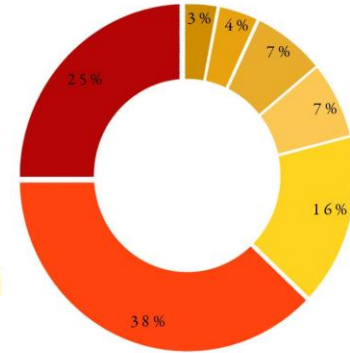
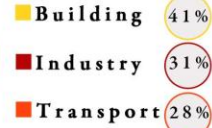
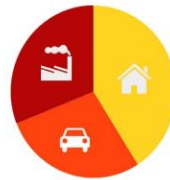
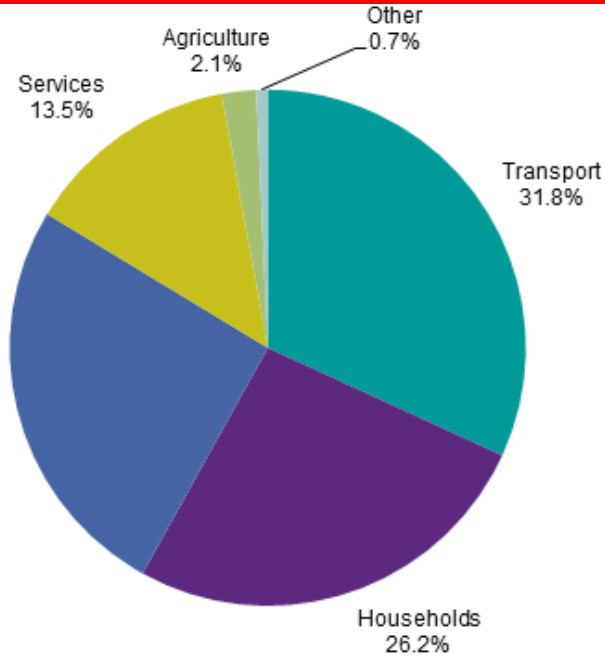

Percentage of energy consumption in Europe

Domestic consumption of energy with despotic conventional heating

Energy source in Europe

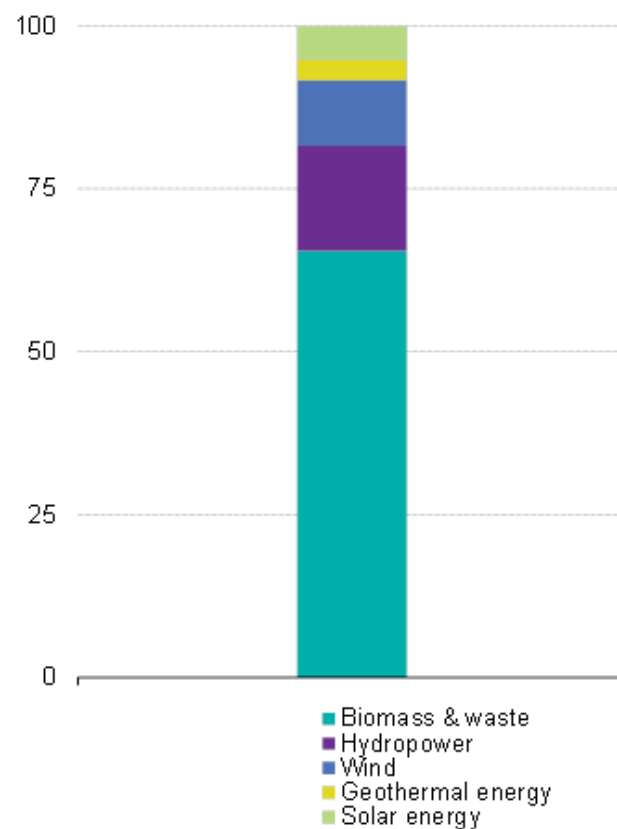
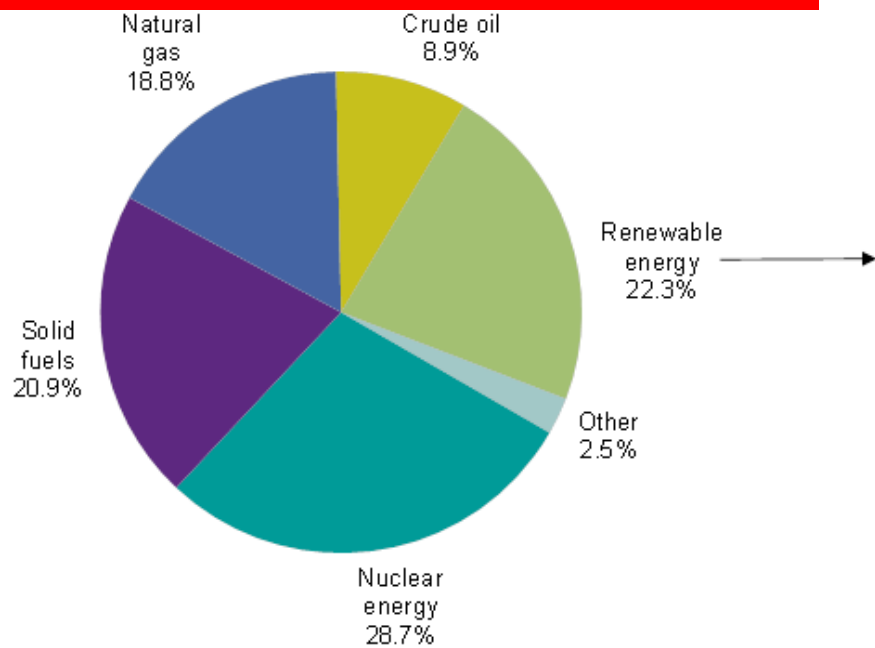

La competizione



Solar Decathlon

Irvine

Washington DC

Cali

Versailles

Madrid

Datong

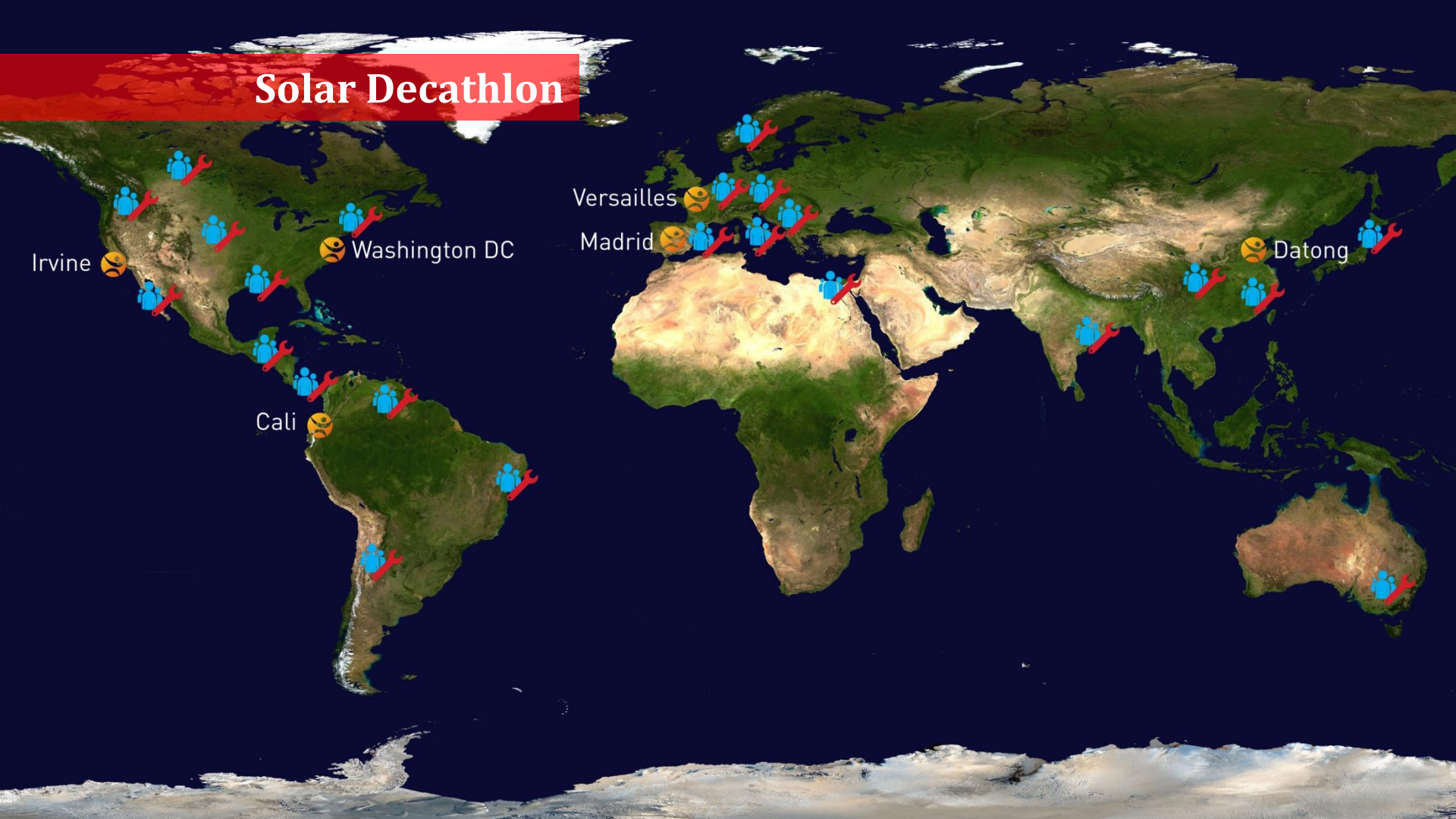

Solar decathlon 2012



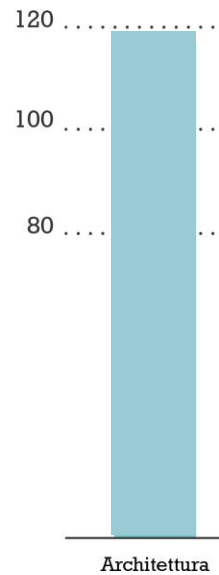



density



Michael Wolf - Honk Kong

mobility



Picture
Alex MacLean

sobriety



affordability

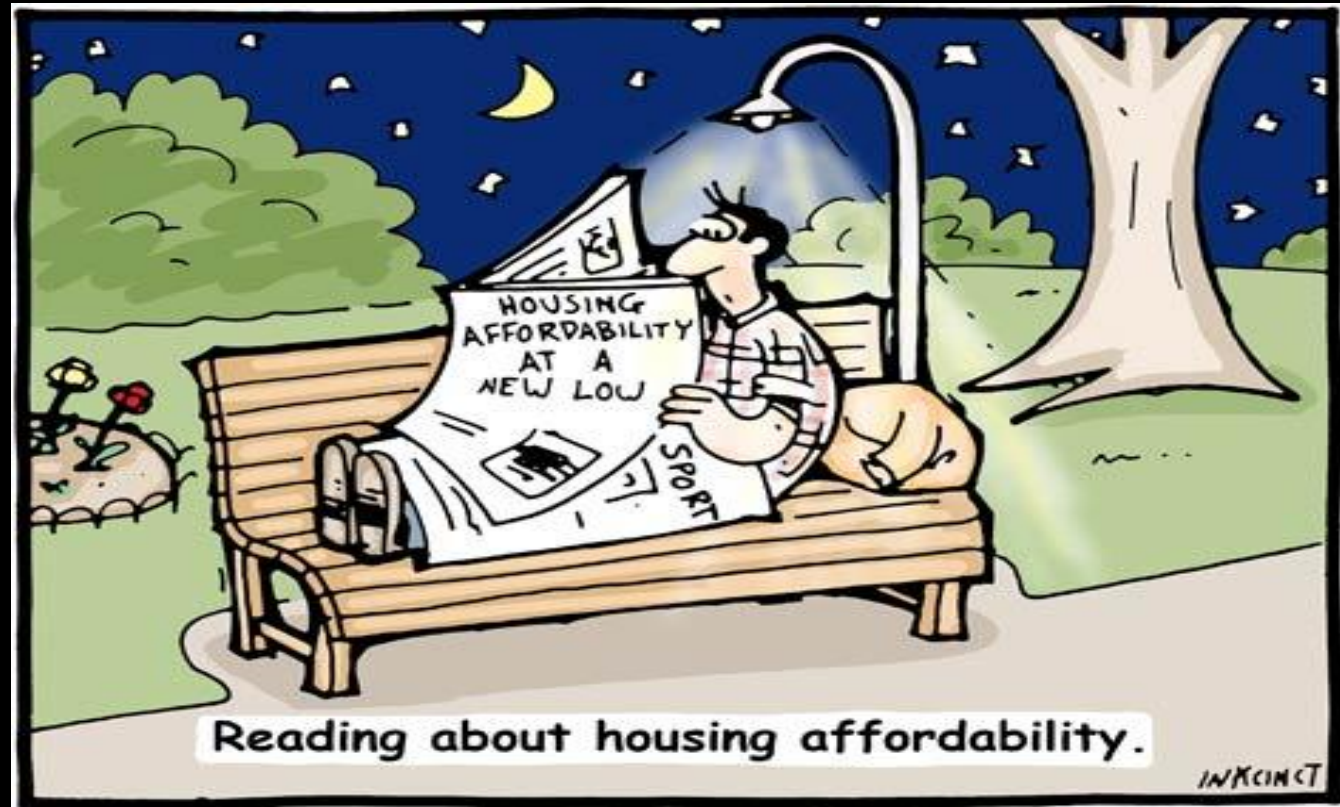

ROME

The logo for 'ROME' is presented in a bold, white, sans-serif font. The letters 'R' and 'O' are solid white. The letter 'M' is partially obscured by a light gray geometric shape that resembles a mountain peak. The letter 'E' is partially obscured by a bright green geometric shape that also resembles a mountain peak. The final 'E' is solid white and is partially obscured by a green shape that looks like a folded corner of a page.

a home for Rome





OFFICIAL SELECTION
COMPETITION
FESTIVAL DE CANNES



colonna sonora originale

LA GRANDE BELLEZZA

UN FILM DI PAOLO SORRENTINO

Acquedotto Appio Claudio - Roma



Acquedotto Felice - ROMA



Acquedotto Felice - ROMA



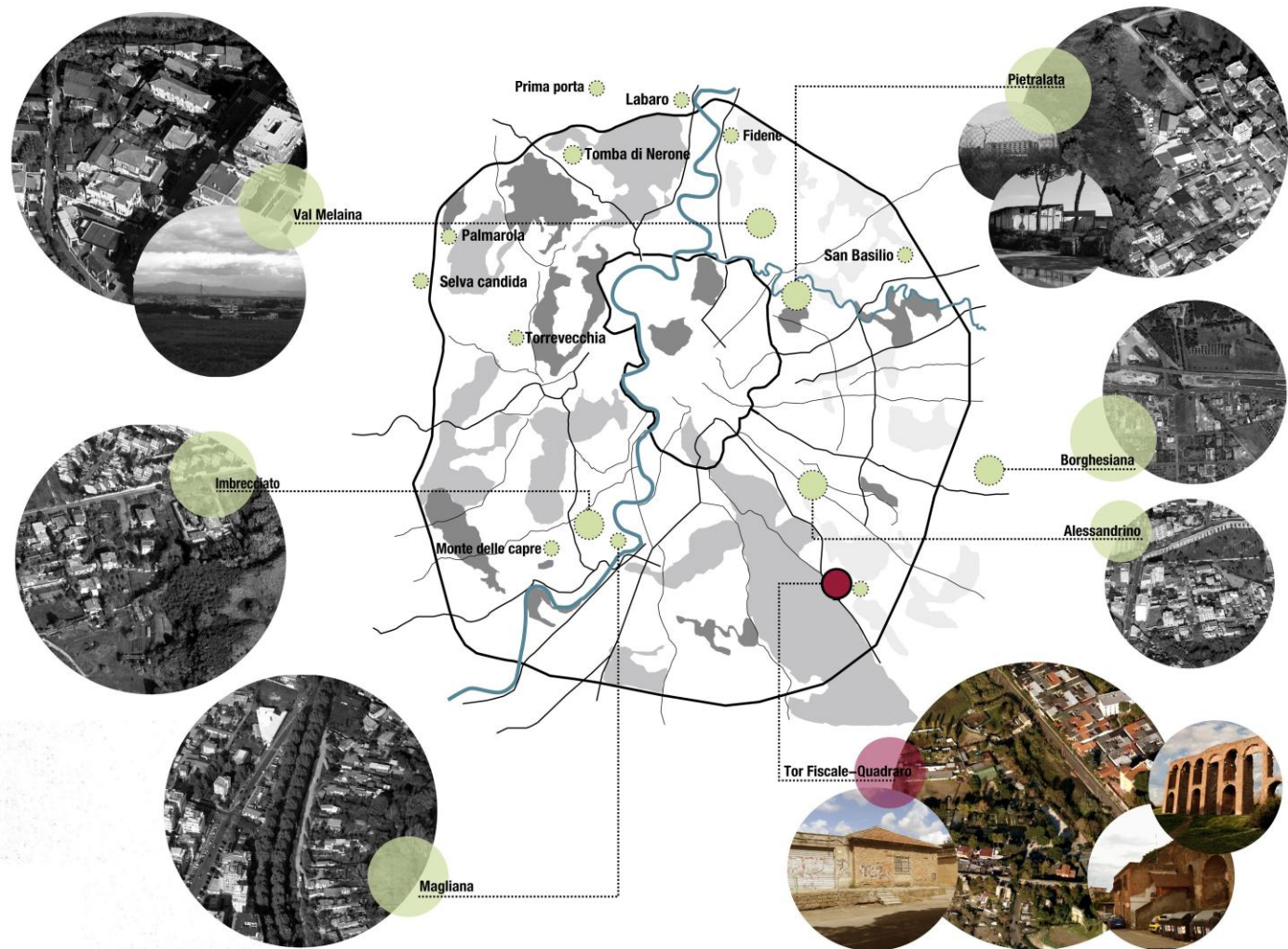

Tor Fiscale: demolizioni







Riscoprire la Grande Bellezza



Social Housing



Servizi

RhOME project



Wifi zone



Fab-Lab



Civic center



play area



rest area



zone 30



cycle path



pedestrian path



tram path



underground stop



urban gardens



Market place



archeological parks



orchard



wineyard

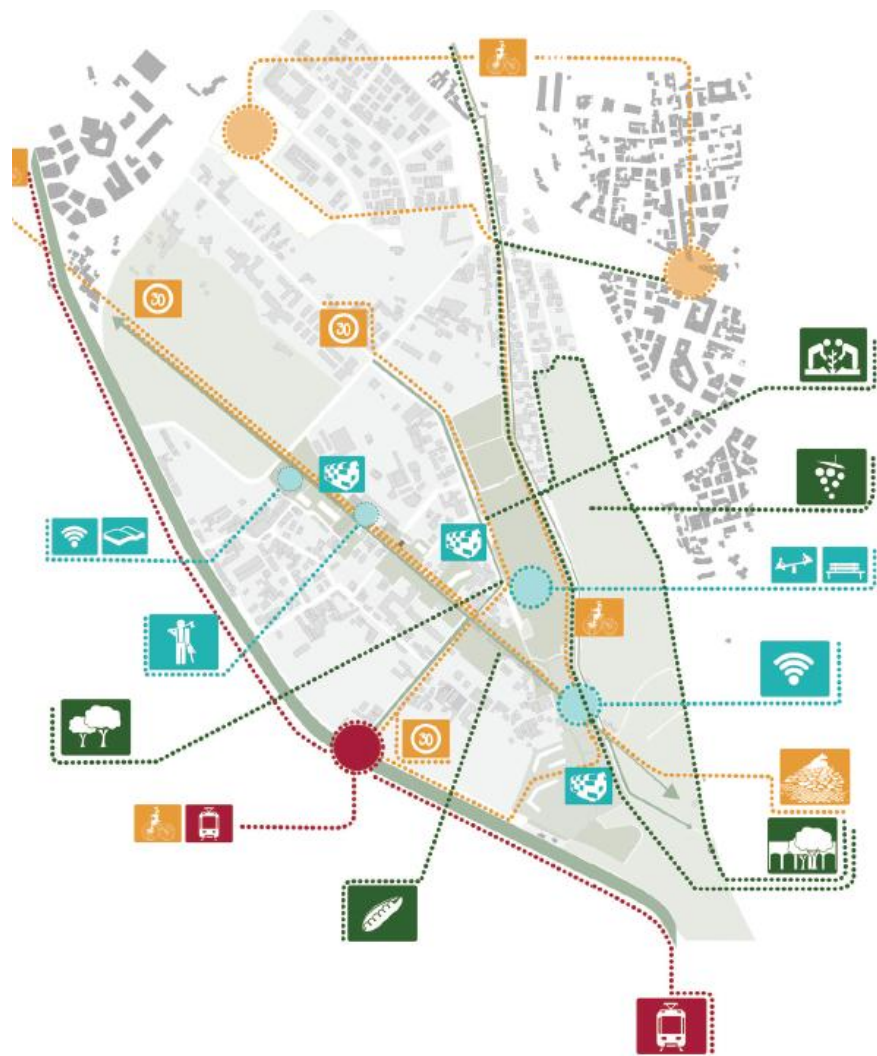





10 giorni per la costruzione



Il prototipo



RhOME for denCity



RhOME for denCity



Le innovazioni di RhOME



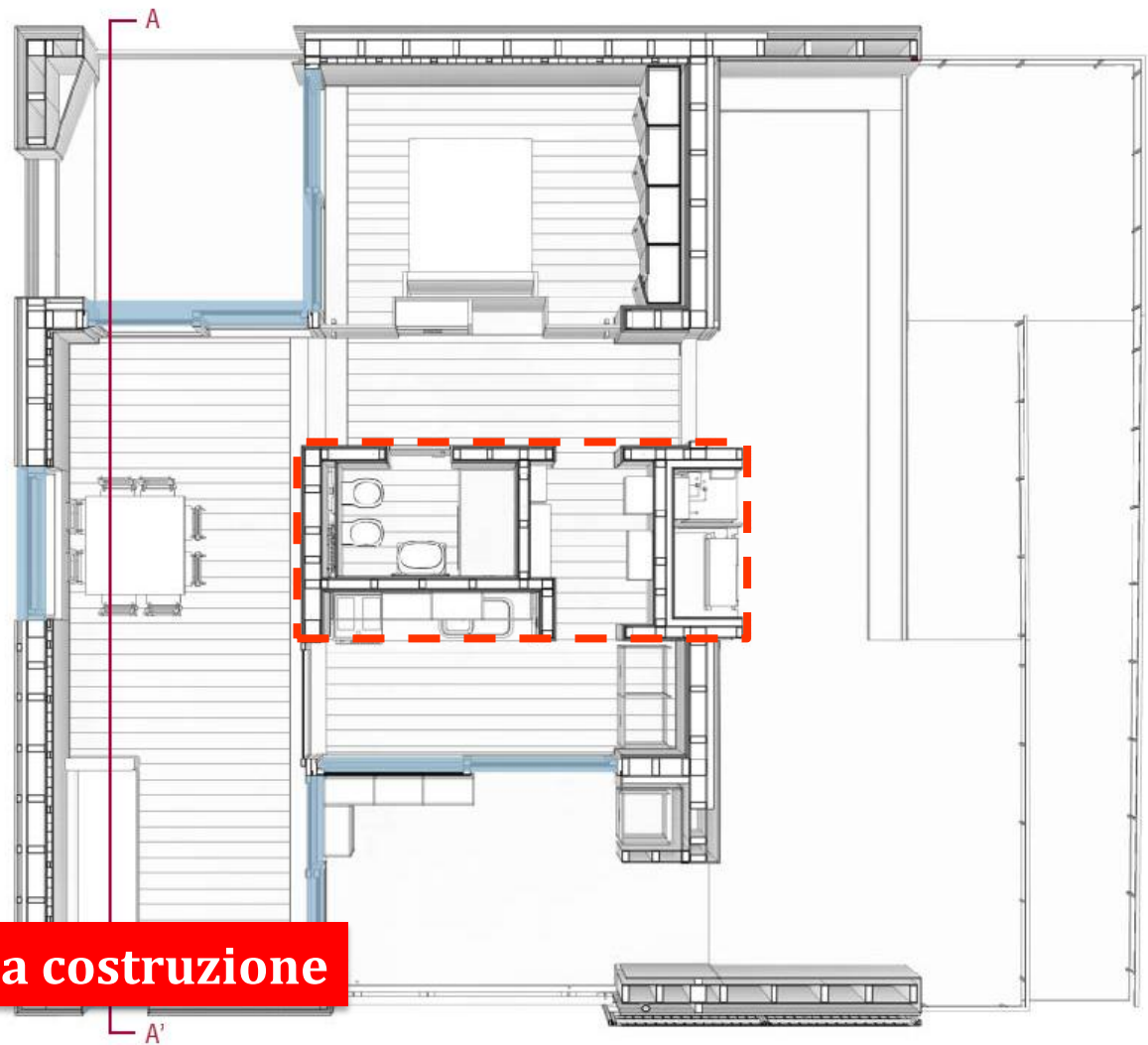

Accelerare la costruzione

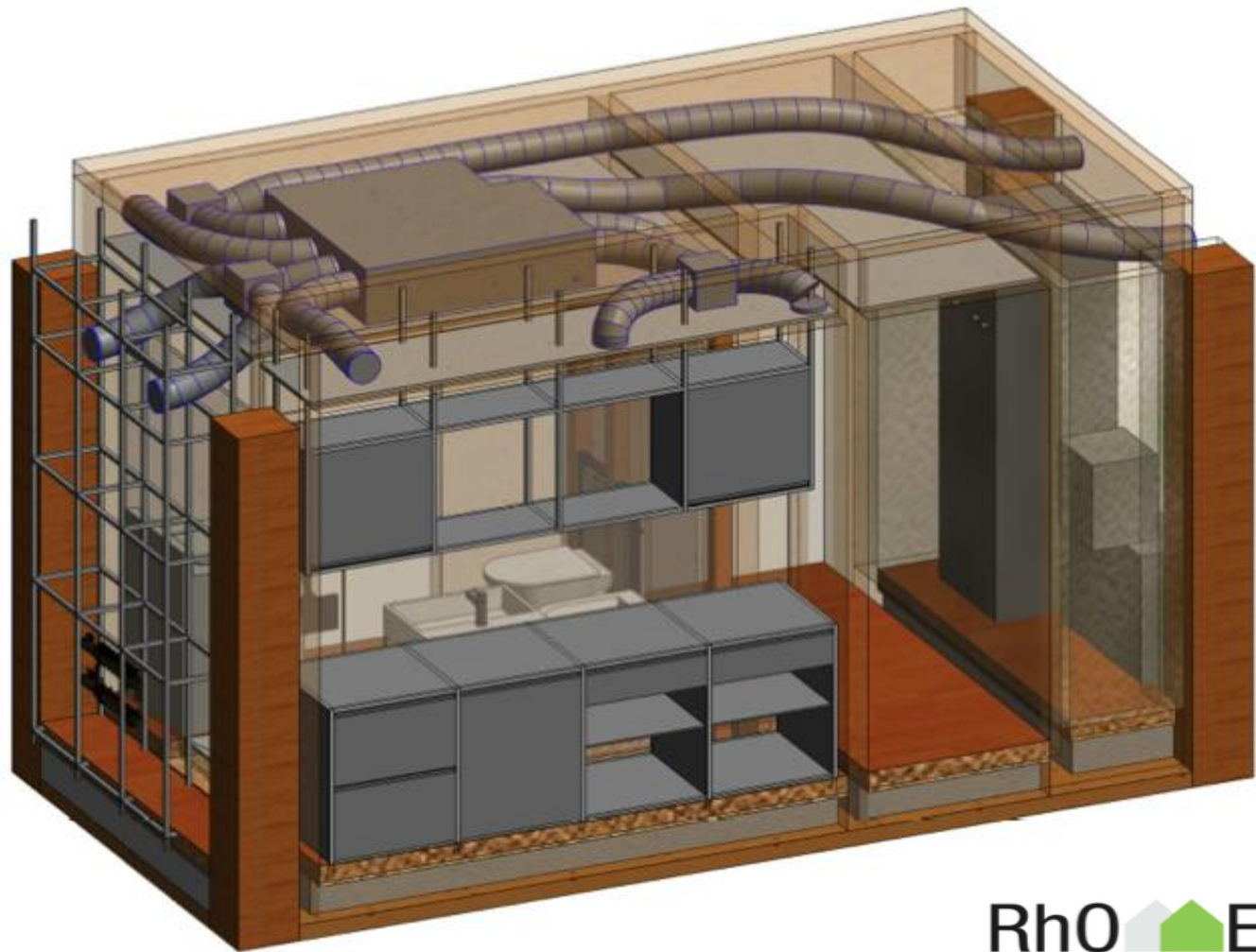



Favorire il comportamento passivo

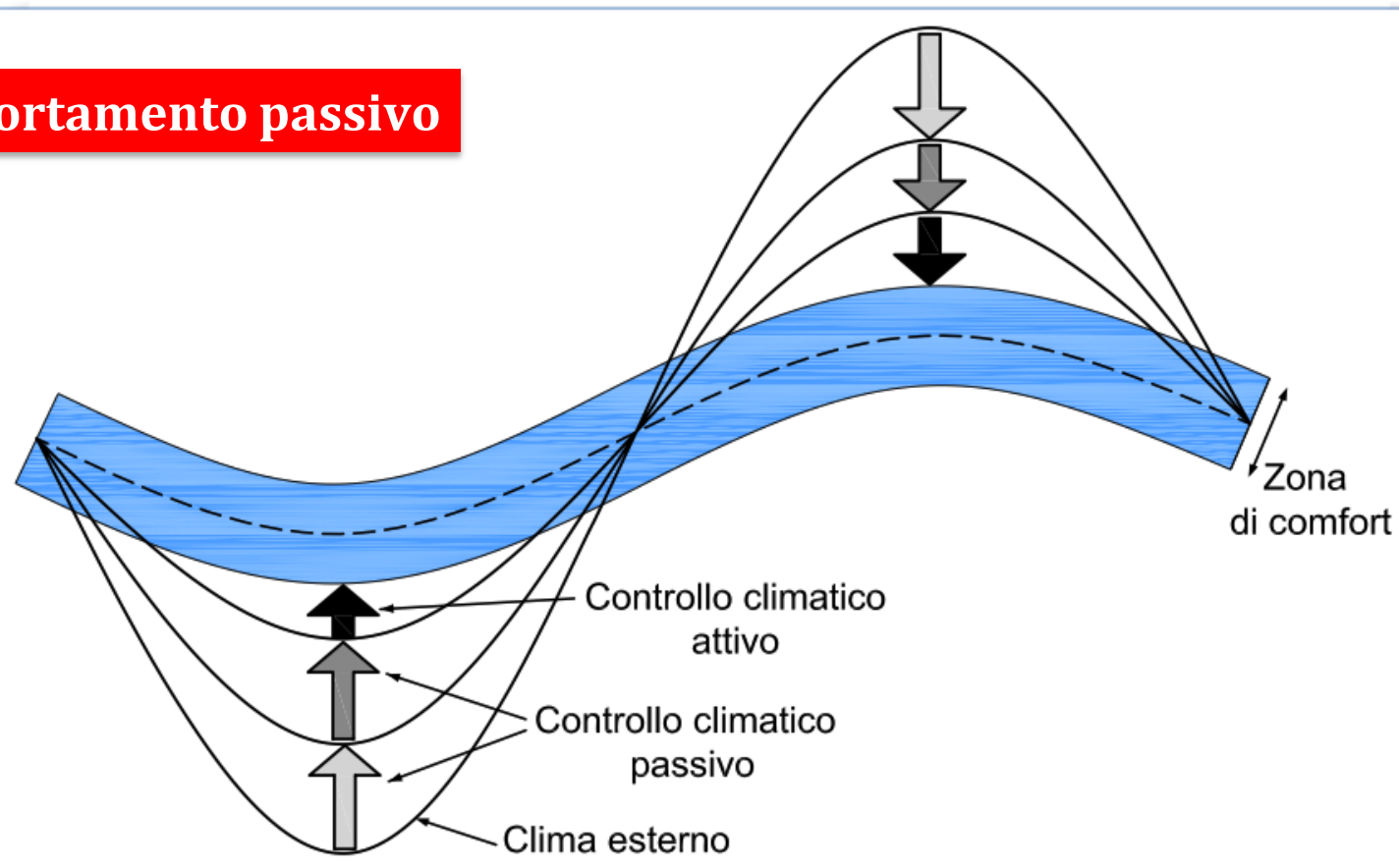



-1°C



CONSUMI x3







108

702

45

17

5T



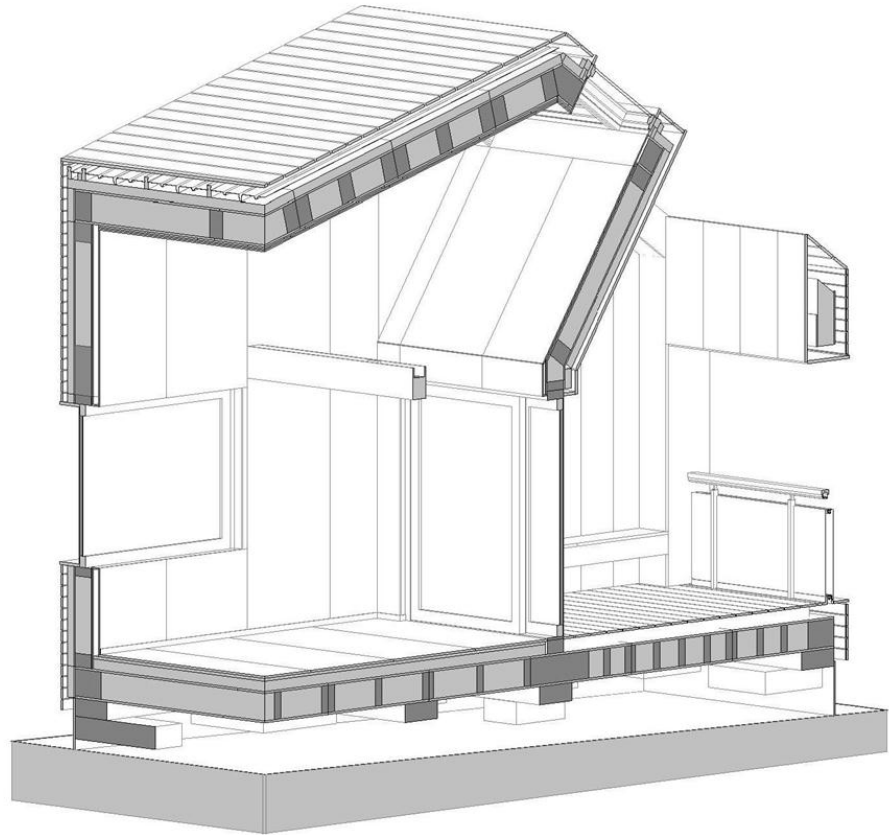

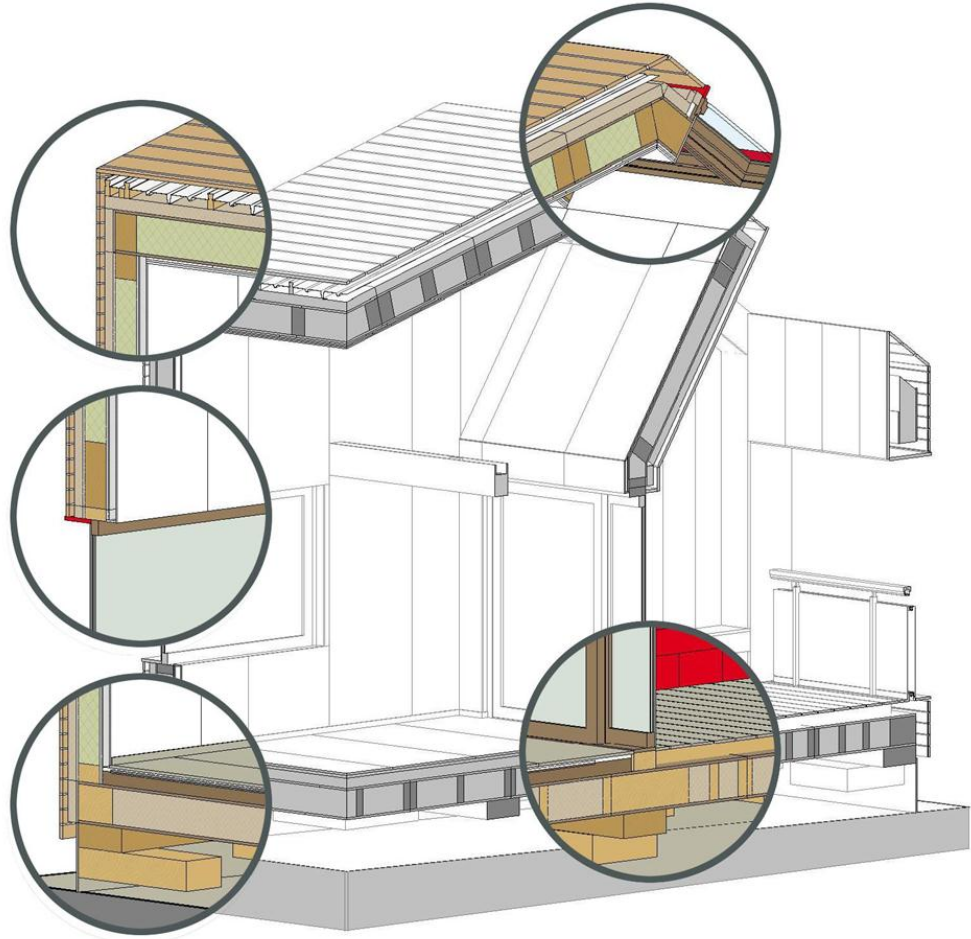

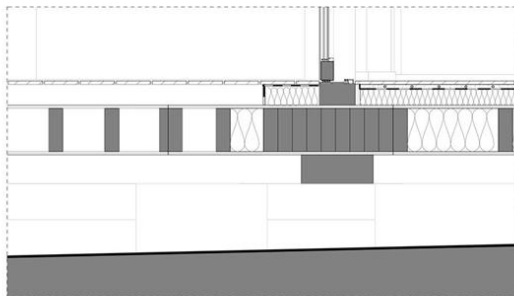
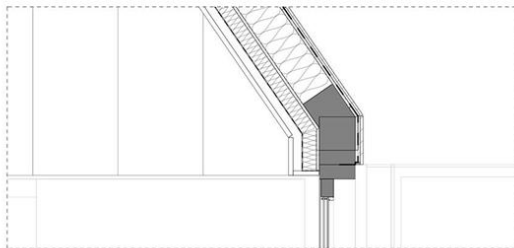
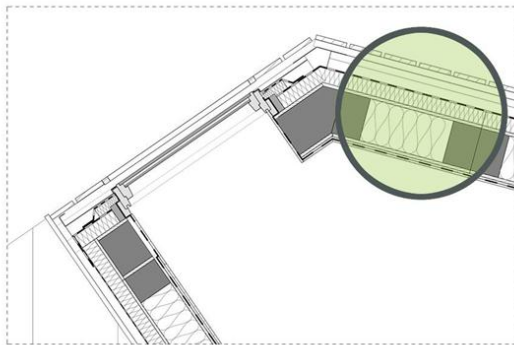

Vertical Section – S1

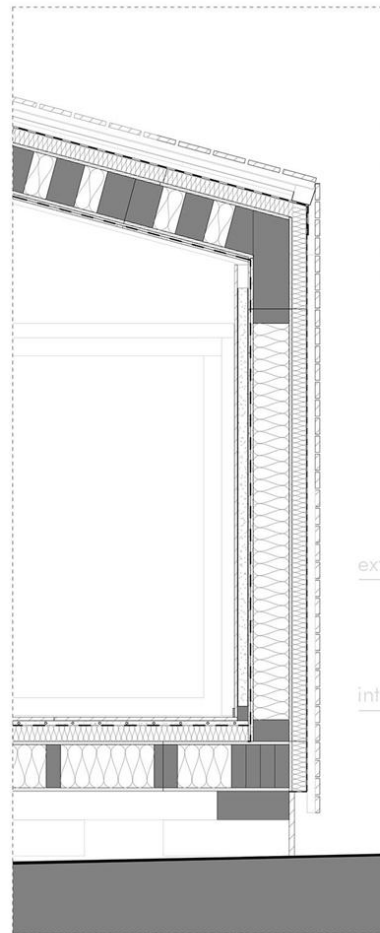

Vertical Section – S2

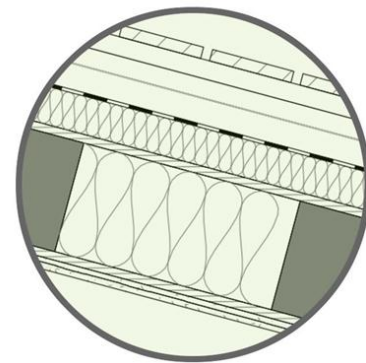

PlatformFrame roof - 56,22cm

- 1 - Wood finishing (Larch) - 2,5 cm
- 2 - Ventilated air cavity + spruce timber - 4 cm
- 3 - Corrugated sheet + spruce timber - 10 cm
- ext 4 - Stamisol Pack 500 - 0,07 cm
- 5 - High density fiber wood - 8 cm
- 6 - Superpan Tech P5 - 1,8 cm
- 7 - Low density fiber wood + spruce timber - 24 cm
- int 8 - Superpan Tech P5 - 1,8 cm
- 9 - Fibergypsum - 1,5 cm
- 10 - Gypsum board - 1,25 cm
- 11 - Wood finishing (Spruce) - 1,3 cm

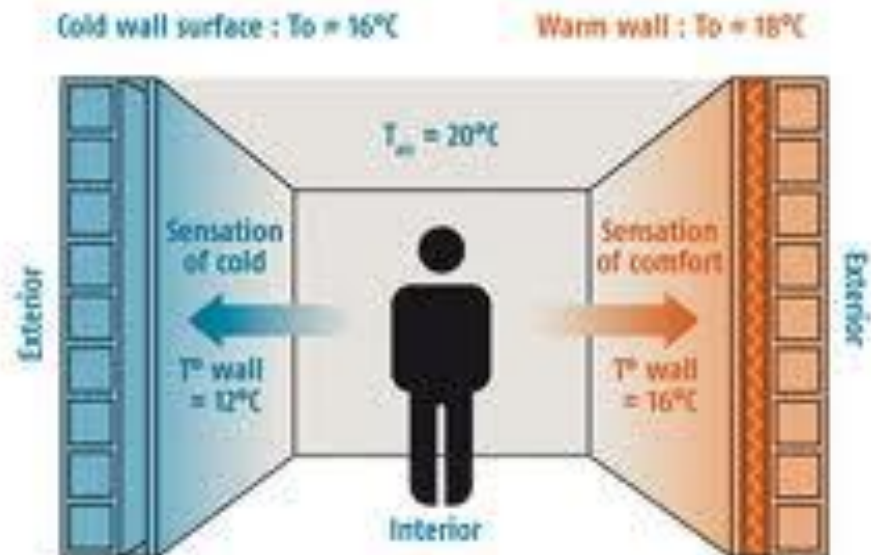

The thermal comfort temperature depends on air temperature and wall temperatures.

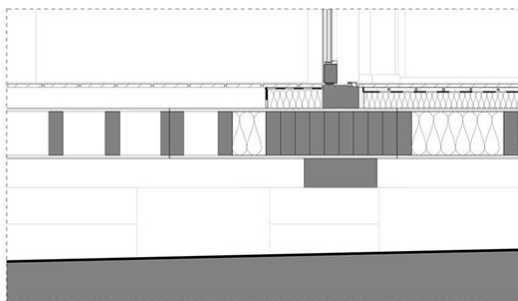
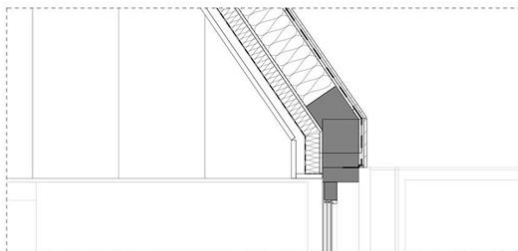
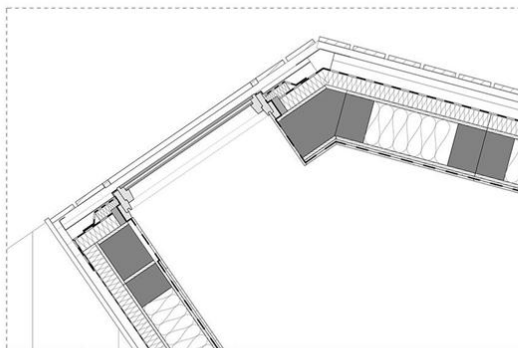

Vertical Section – S1

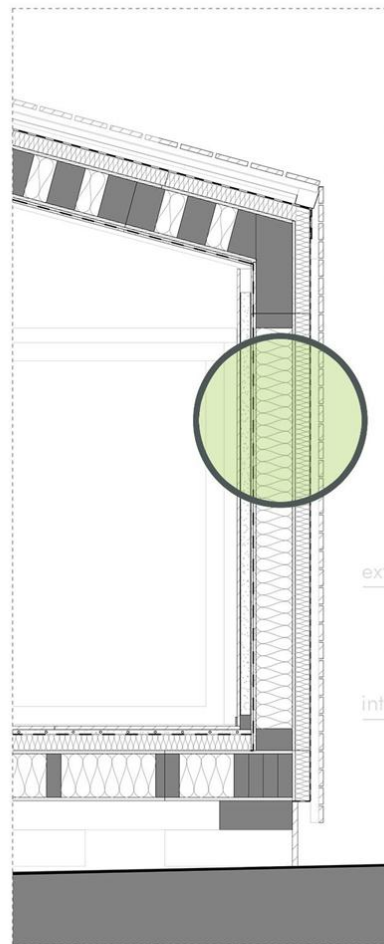

Vertical Section – S2

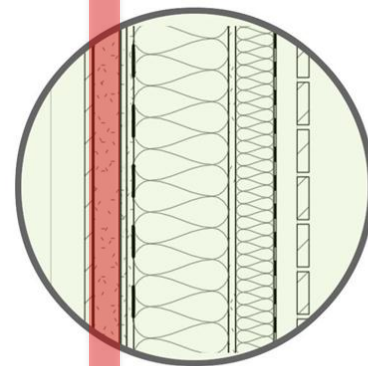

Mass PlatformFrame wall - 47,5cm

- 1 - Wood finishing (Larch) - 2,5 cm
- 2 - Ventilated air cavity + spruce timber - 5 cm
- 3 - Stamisol Color Red - 0,07 cm
- ext 4 - High density fiber wood - 8 cm

- 5 - Fibergypsum - 1,5 cm
- 6 - Low density fiber wood + spruce timber - 20 cm
- 7 - Breathable sheet - 0,075 cm
- int 8 - Fibergypsum - 1,5 cm

- 9 - Gypsum board - 1,25 cm
- 10 - Wet sand/alluminium profiles/spruce timber - 6 cm
- 11 - Wood finishing (Spruce) - 1,6 cm



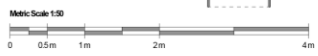
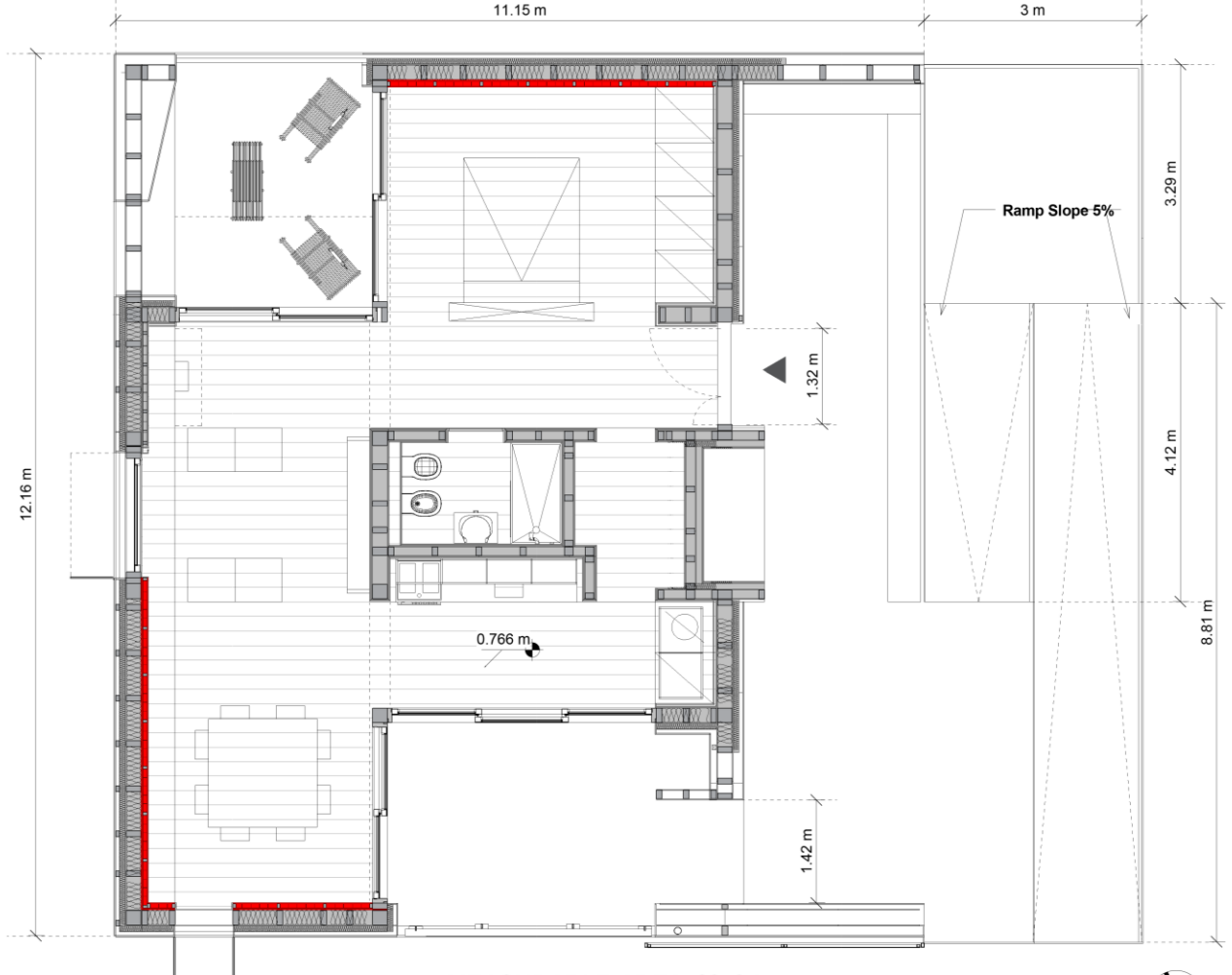

MEASURABLE AREA 62.04mq
interasse montanti 62.5cm

 Thermal mass wall



Winter behavior (Day)

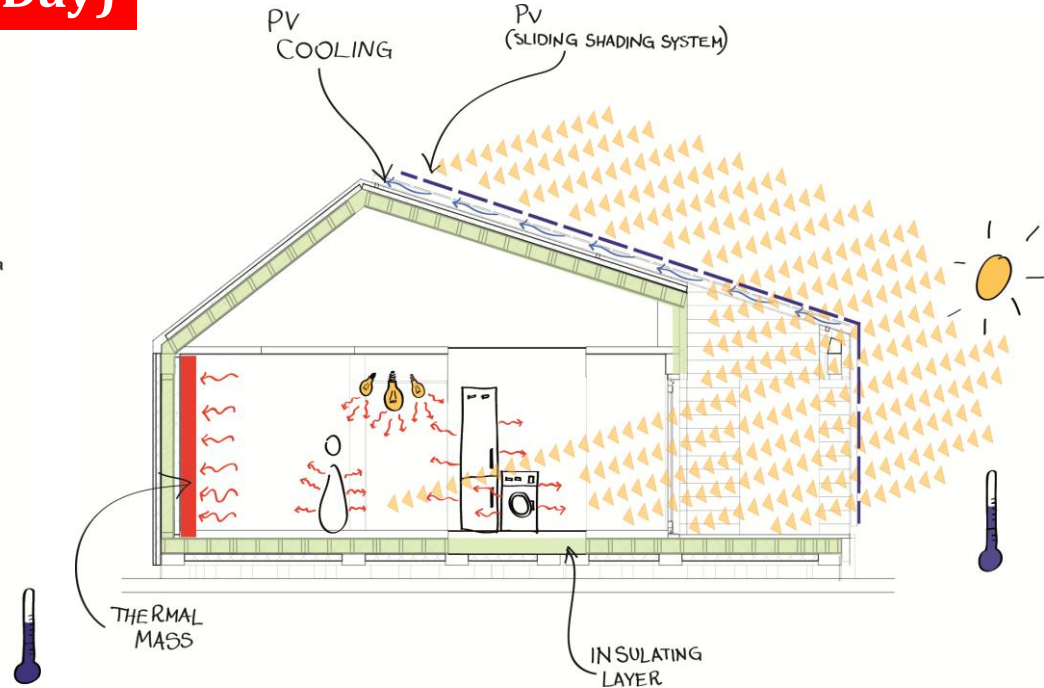
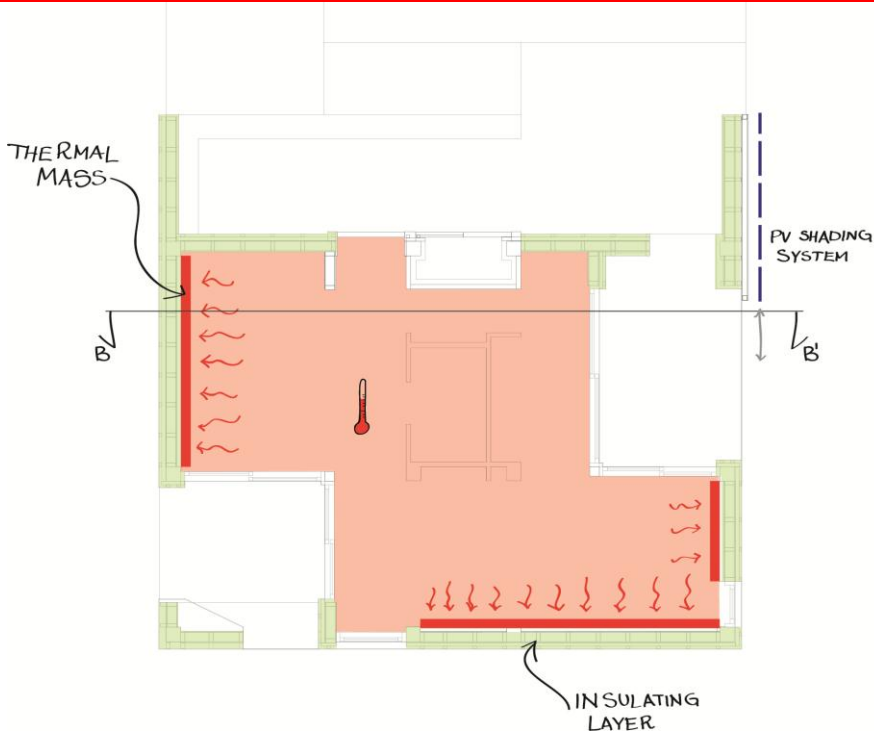

Winter behavior (Night)

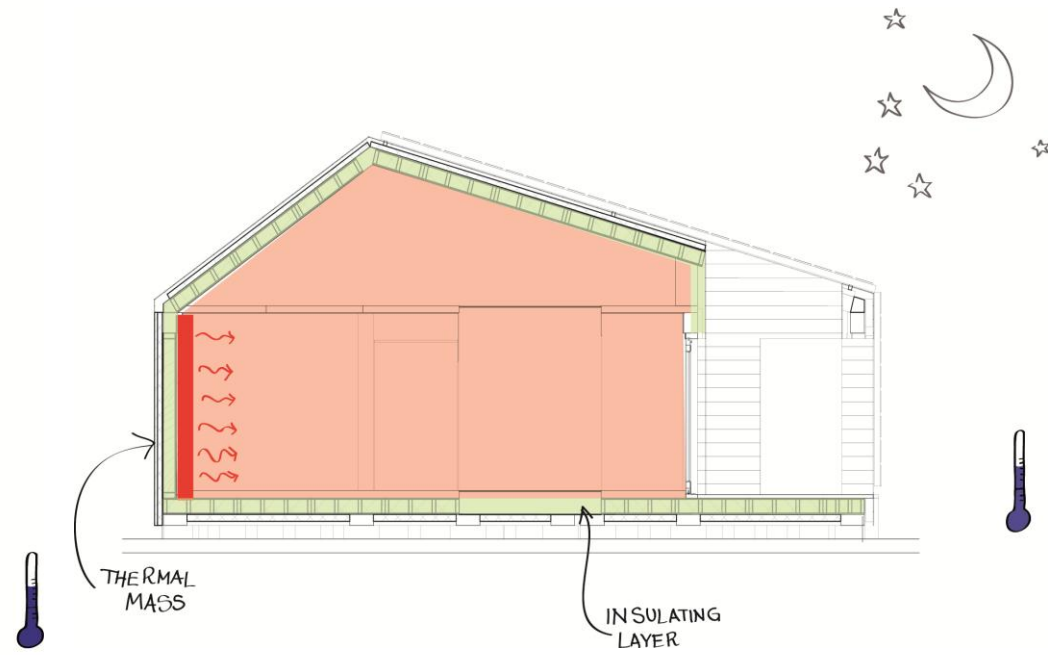
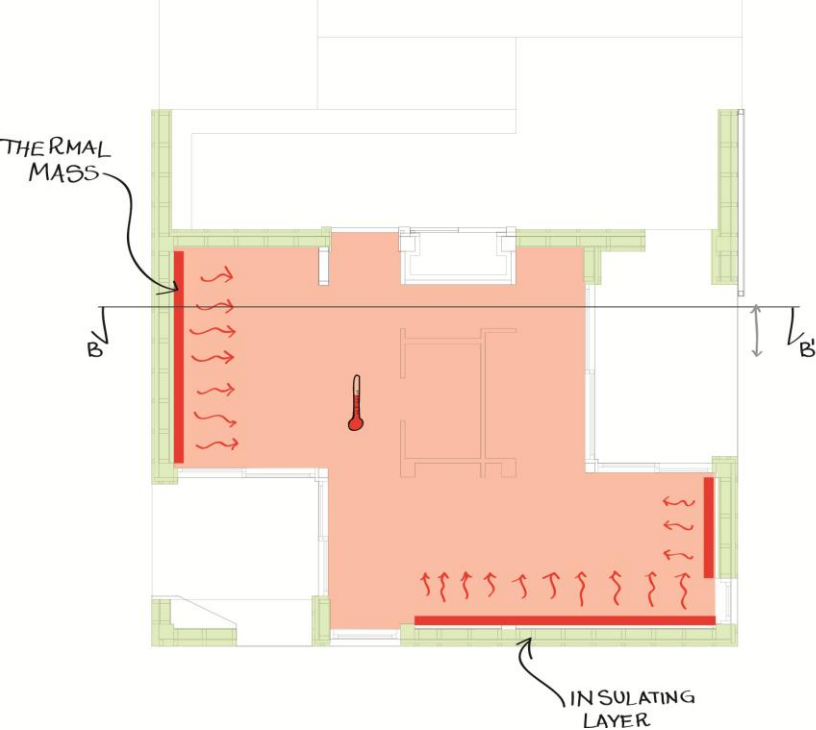

Summer behavior (Day)

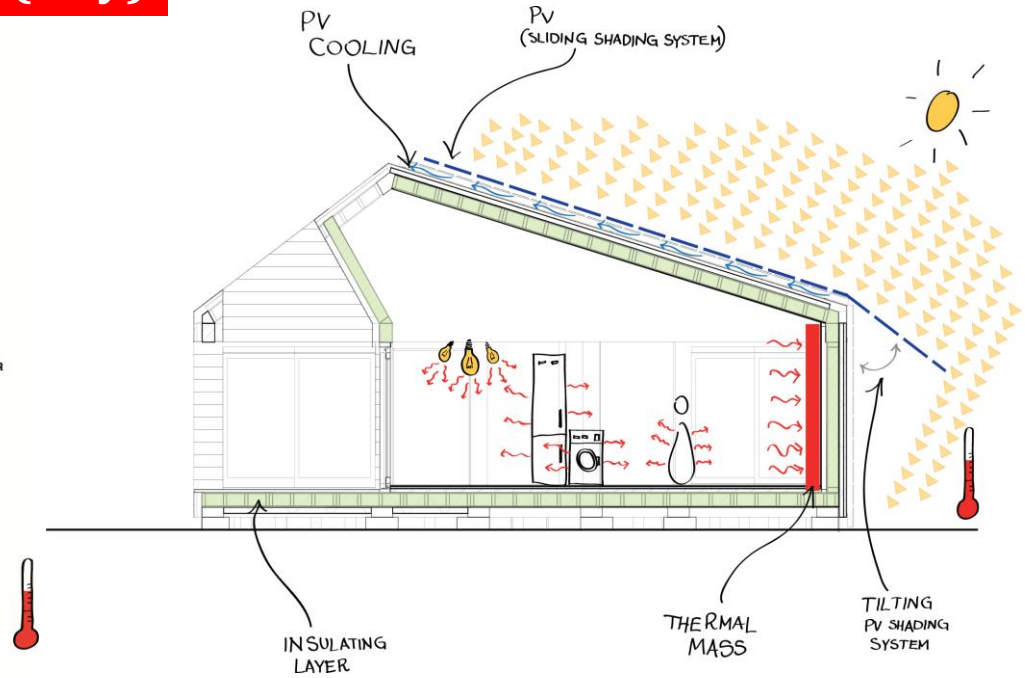
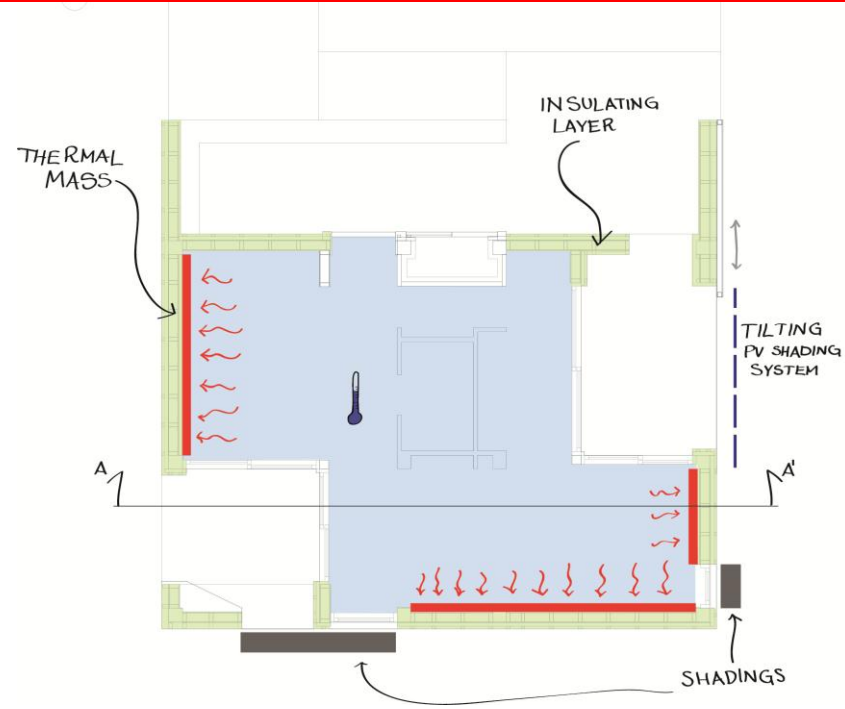

Summer behavior (Night)

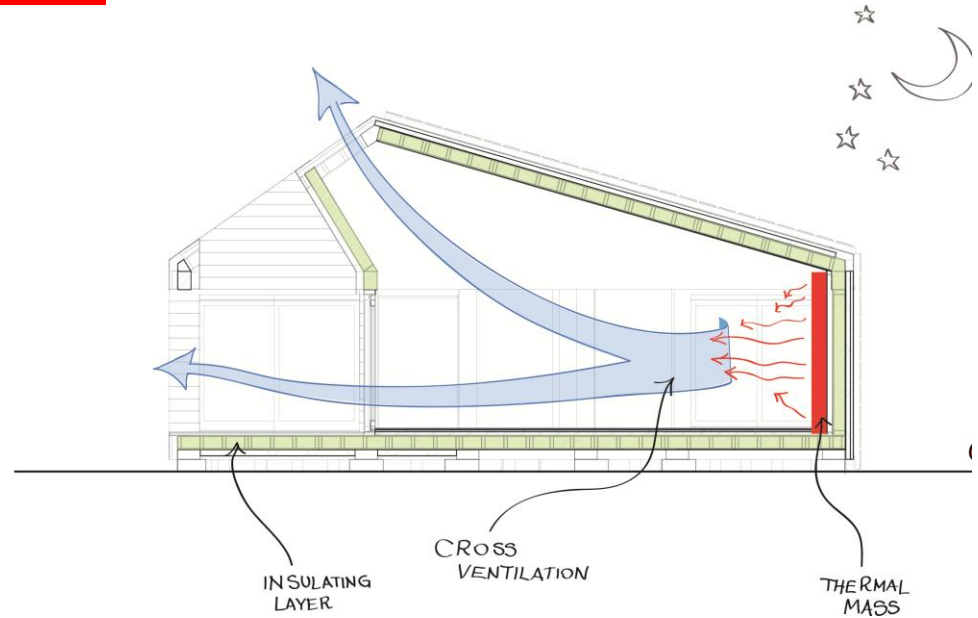
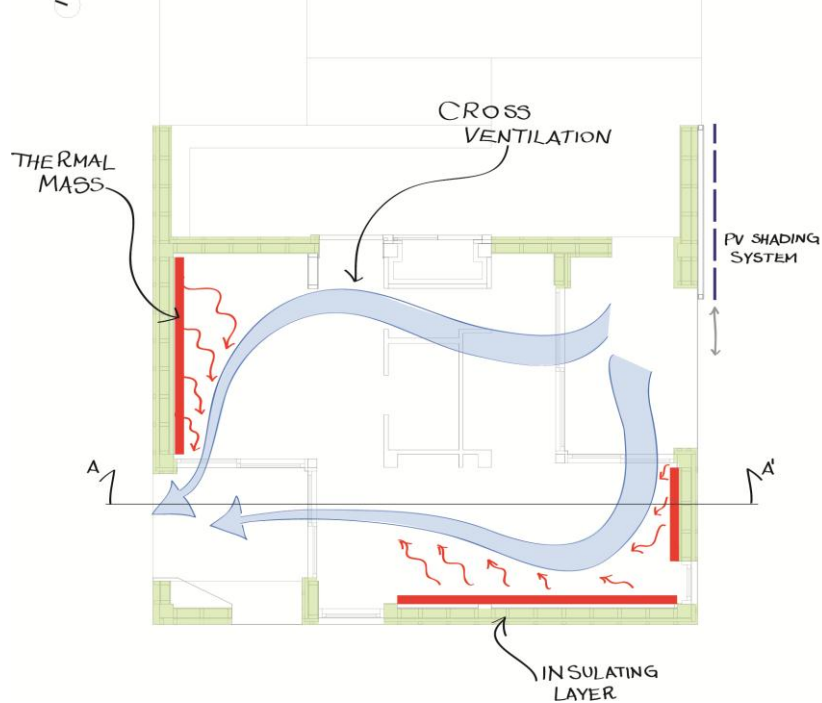

Sorgente

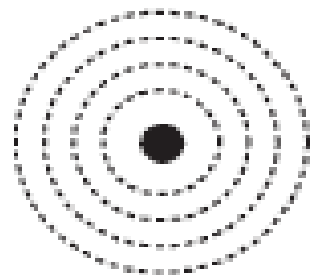

W_1



W_2



Ricettore

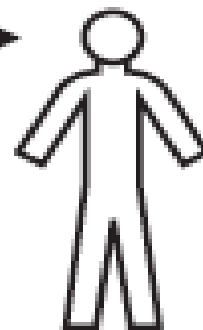



Integrare funzionalmente i sistemi di produzione di energia

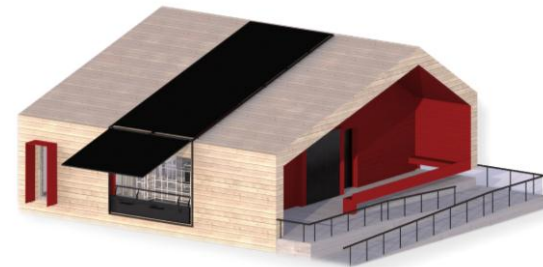
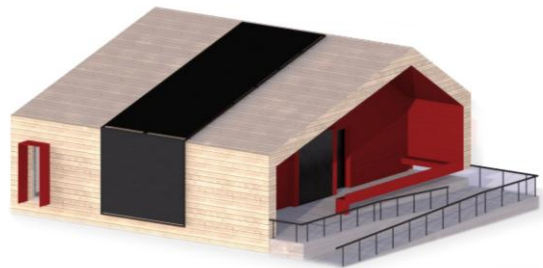
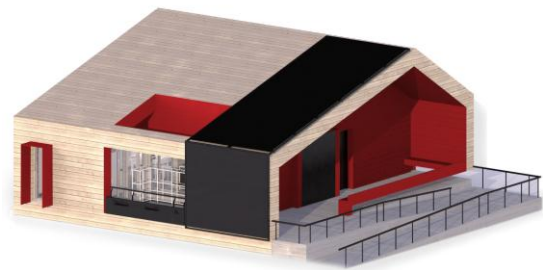

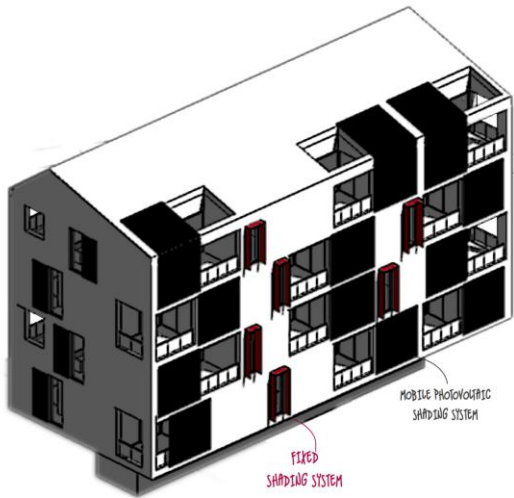

OPEN

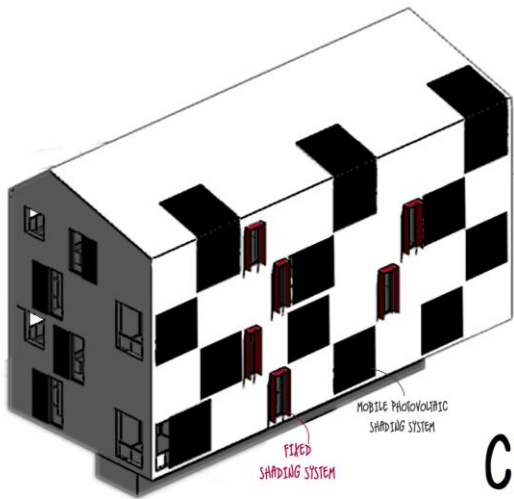

CLOSED

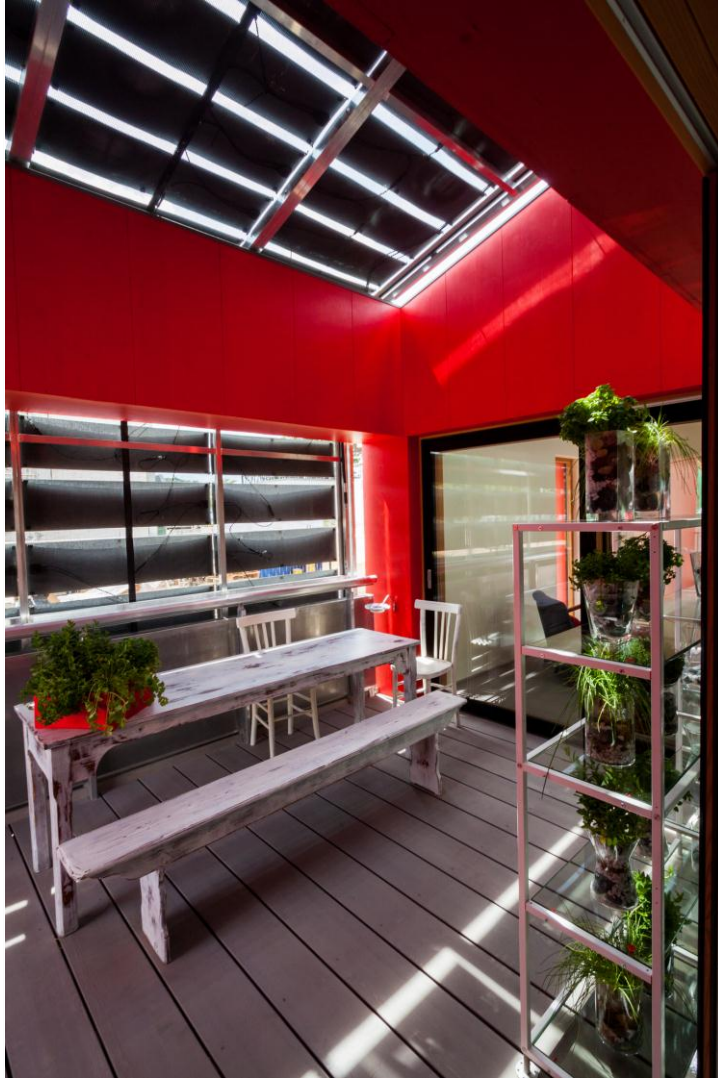

98 pannelli:

98 SOLBIAN FLX SP50L

Dimensioni:

111 x 30 cm

sopessori:

2 mm

Efficienza del singolo pannello

51 W

inverter:

SCHNEIDER Connext RL5000E

Efficienza dell'intero campo

In posizione aperta

4107 kWh

In posizione chiusa

3755 kWh

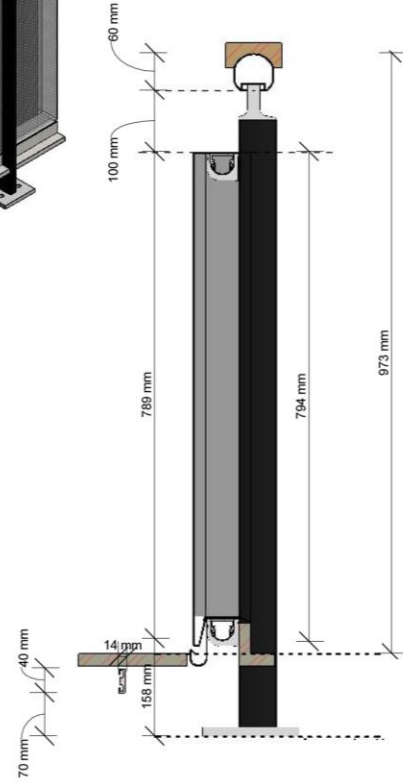
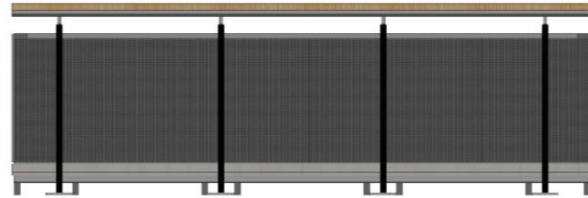
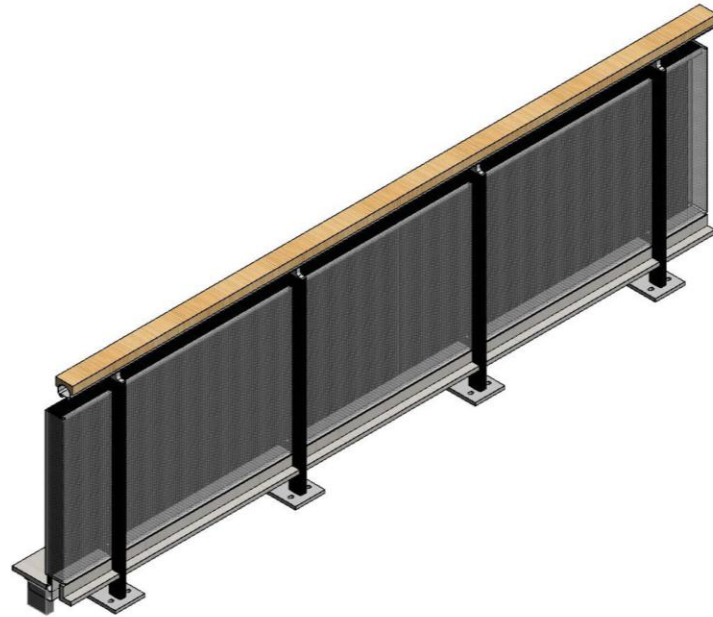

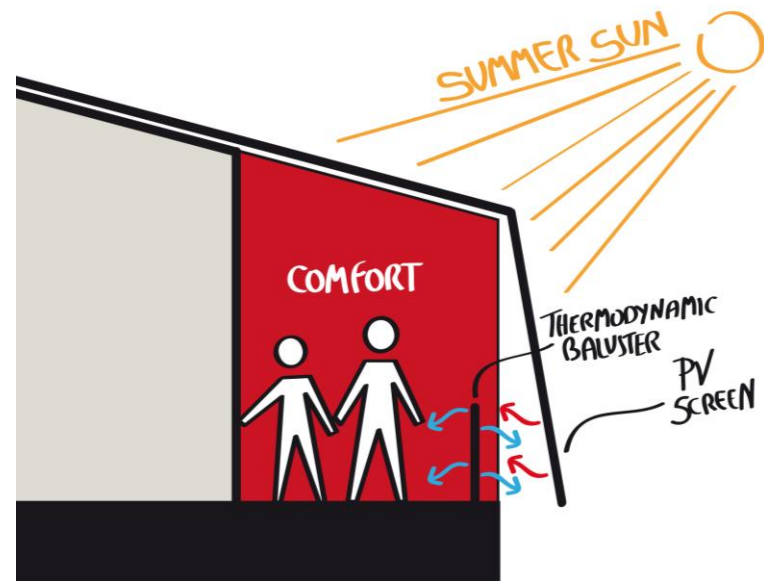

I risultati





Grazie!

